

## 15' x 15' Corner Specifications

### SALON BOOTH PACKAGE INCLUDES:

**Showcase Options:** Two 2M Low (6')  
One 1M Tower (3') and One 2M Low (6')

- Two (2) Wastebaskets
- Nine (9) Wynn Hotel Ballroom Chairs
- Three (3) Tables (*please complete the Salon Package Table Order Form by April 24, 2026*)
- One (1) Track Lighting Bar with six (6) 6000K LED 12 watt fixtures
- Electrical for the showcases and the lights in each booth will be included. Any other items requiring electricity in the Salons will require an electrical order to be placed with Freeman. Please refer to the Freeman Electrical Order Form.
- Custom sign plaque with company name and booth number in Couture Type font
- One time vacuuming prior to show opening
- Daily trash removal (*please leave your wastebasket outside your booth at close of show each day*)

Note: For 2M low showcases only, in addition to track in center, one (1) track with three (3) lights hung behind sign plaque above low showcase will be added.

**Salon Size:** Open Salon measures 15' (4.57M) wide x 15' (4.57M) long x 8' (2.44M) high.  
Please see internal exhibit dimensions on attached renderings.

**Color:** Exterior walls are Morris Oak Wood Laminate. Interior walls are Light Gray Laminate.

**Decorating Interior of Salons:** All materials or adhesives must be removed from panels, showcase shelves and showcase doors at close of show. Any remaining materials or adhesives will be removed at an additional labor cost to the exhibitor.

### PLEASE NOTE:

- **There is a weight limit of 50 lbs. for each 1M wall panel.**
- **For stability, no additional lights can be added to the sign light track.**

**Freeman will provide two (2) design renderings at No Charge for Salon customizations or changes. Additional revisions will be charged at \$250.00 each.**

**All salon structure changes and/or customizations must be finalized by April 24, 2026. Changes made after April 24, 2026 will incur 30% surcharge. On April 25, 2026, your salon will be ordered at the package you purchased through COUTURE management.**

Please contact [CoutureSales@freeman.com](mailto:CoutureSales@freeman.com) to discuss further customizing your space.

# 15 X 15 CORNER SALON

## 2M Low Showcases Option

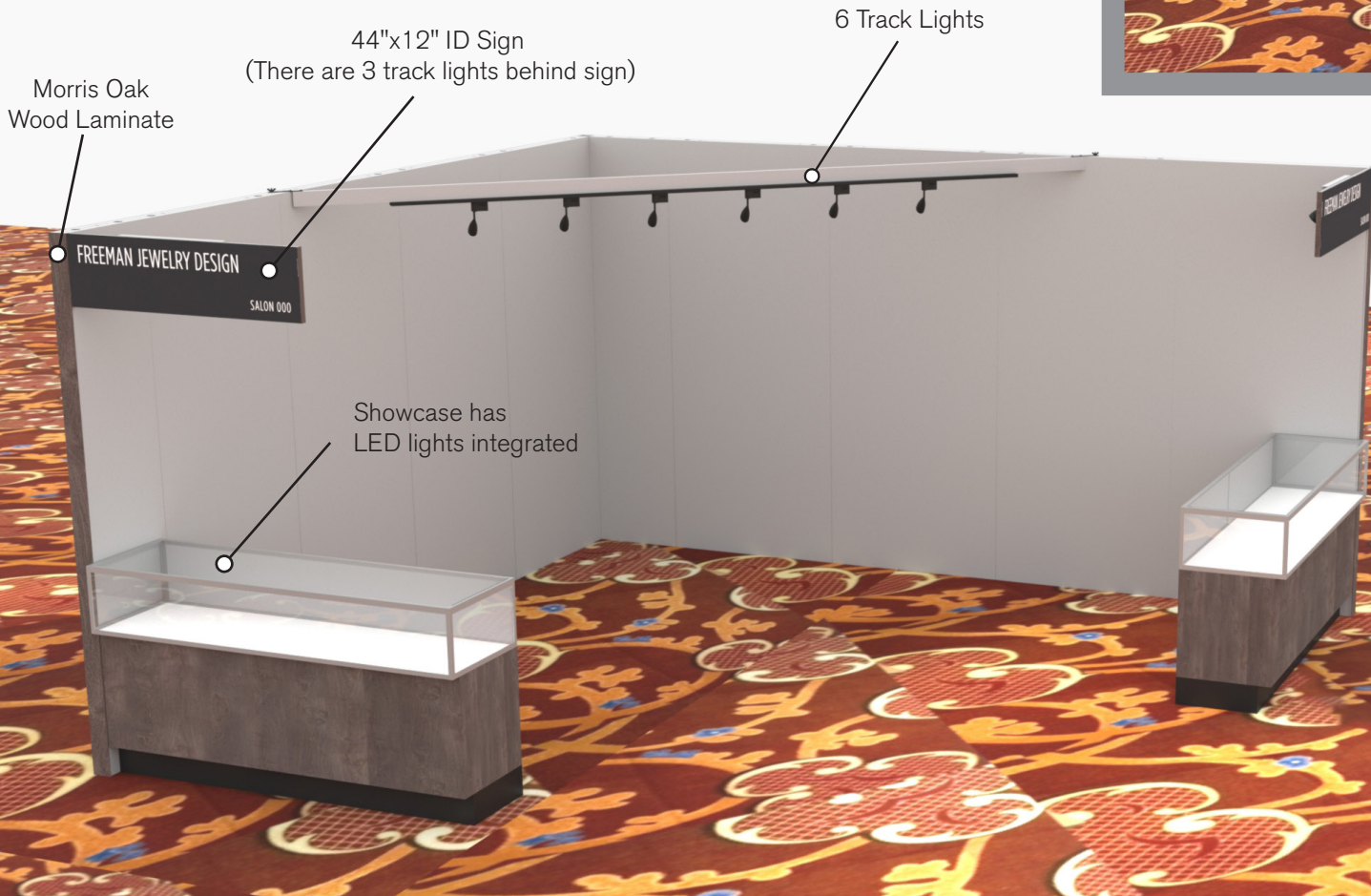
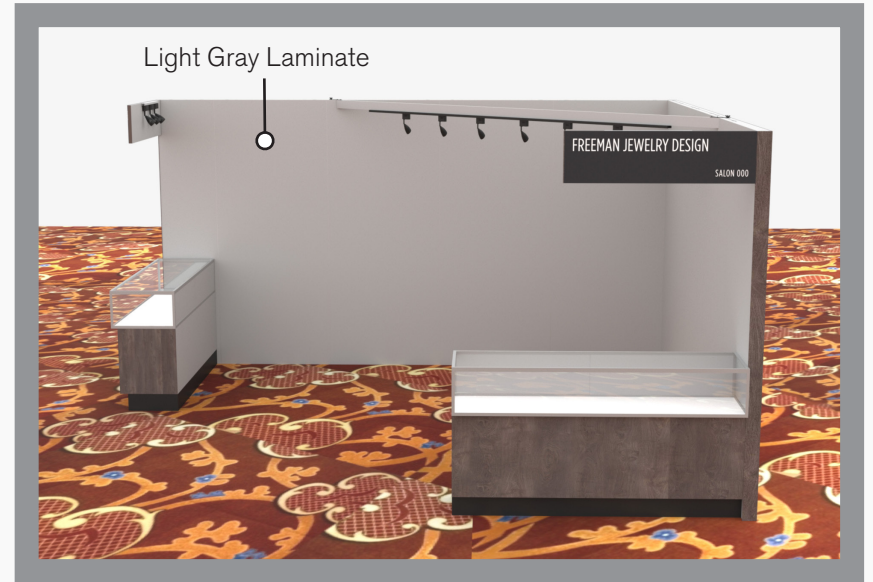

### 15x15 Premium Corner 2M Low Showcases

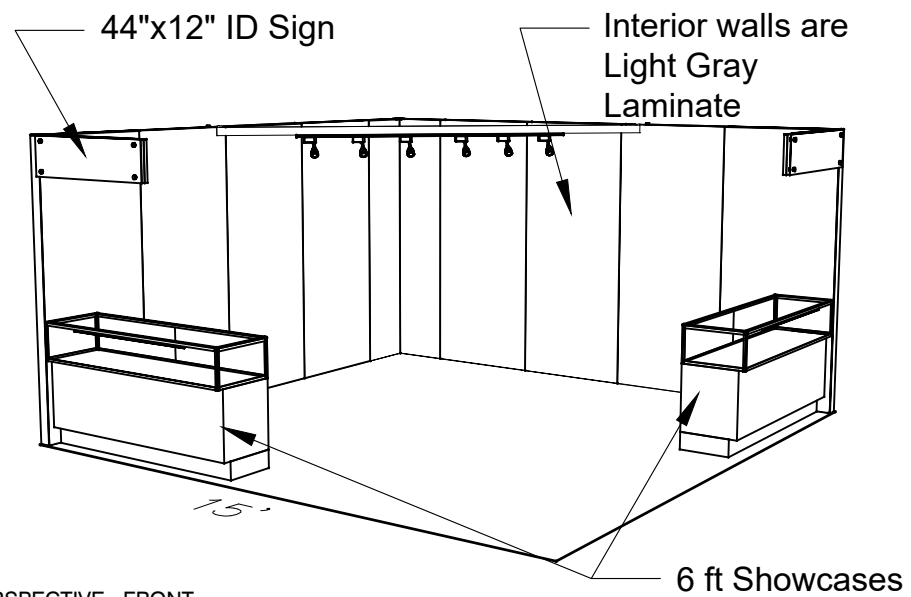

PERSPECTIVE - FRONT

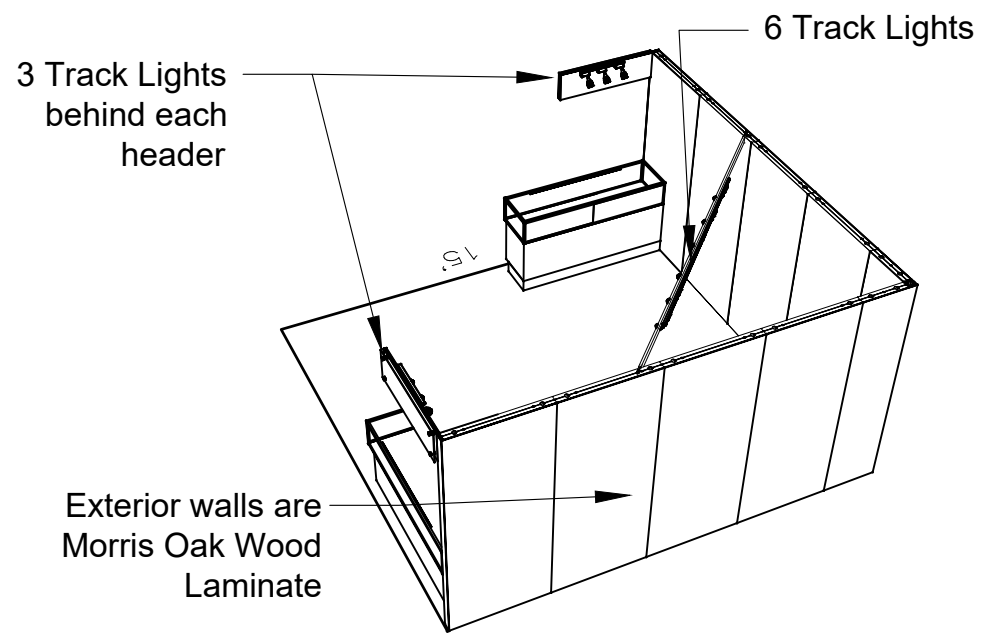

PERSPECTIVE - BACK

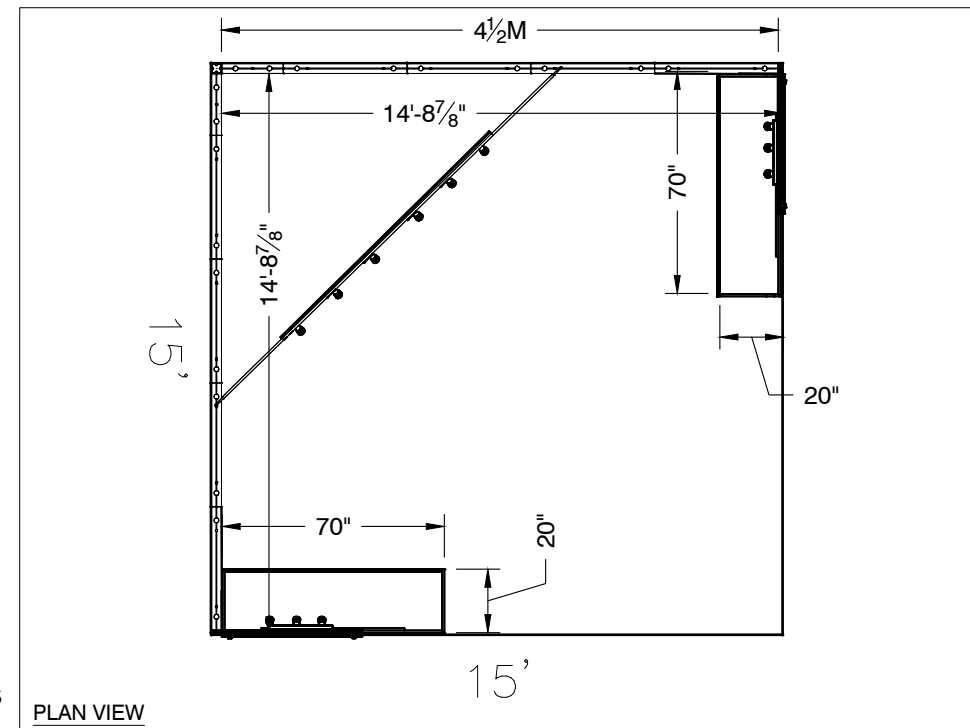

PLAN VIEW

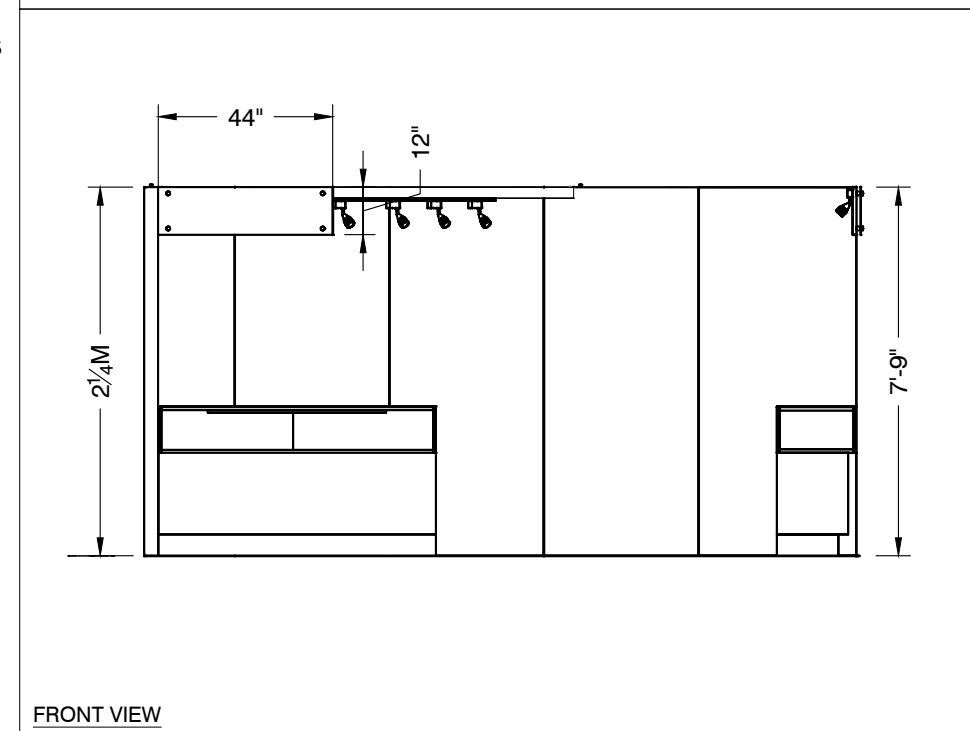

FRONT VIEW

LESS THAN 30 DAYS OUT



\* 0 0 5 0 5 9 0 7 0 1 - 1 0 1 1 - 0 \*

MORE THAN 30 DAYS OUT



\* 0 0 5 0 5 9 0 7 0 1 - 1 0 1 1 - 1 \*

# 15 X 15 CORNER SALON

1M Tower and Showcase Option

44"x12" ID Sign  
(There are 3 track lights behind sign)

Morris Oak  
Wood Laminate

6 Track Lights

Showcase has  
LED lights integrated

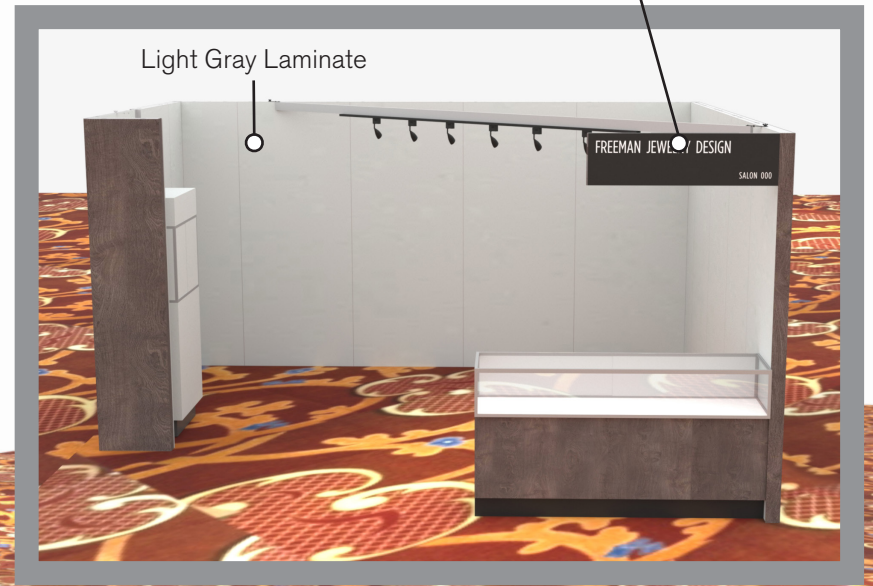

Light Gray Laminate

FREEMAN JEWELRY DESIGN  
SALON 000

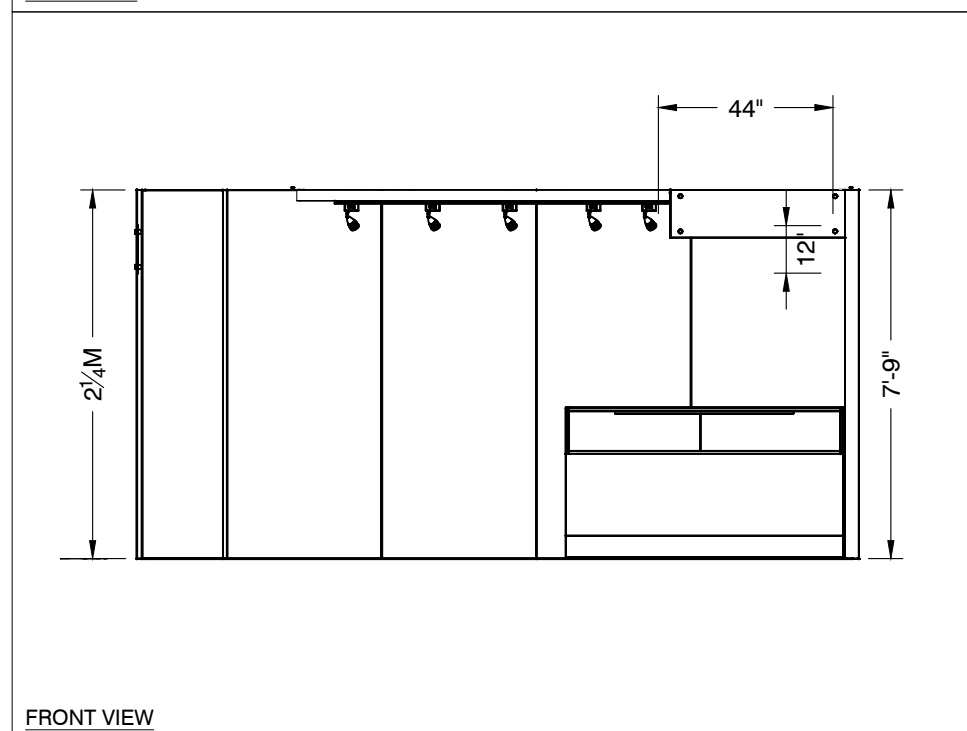
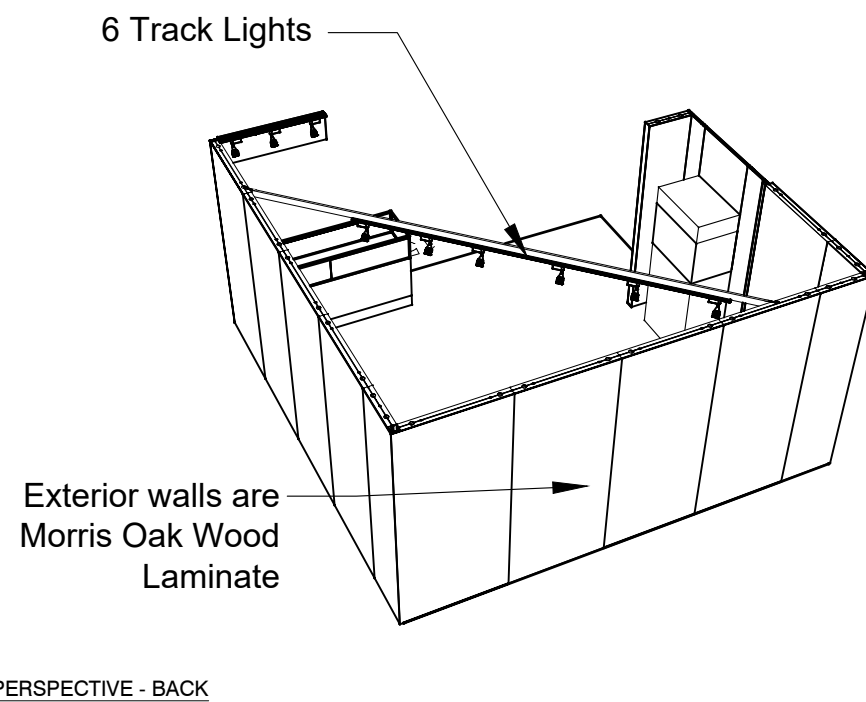
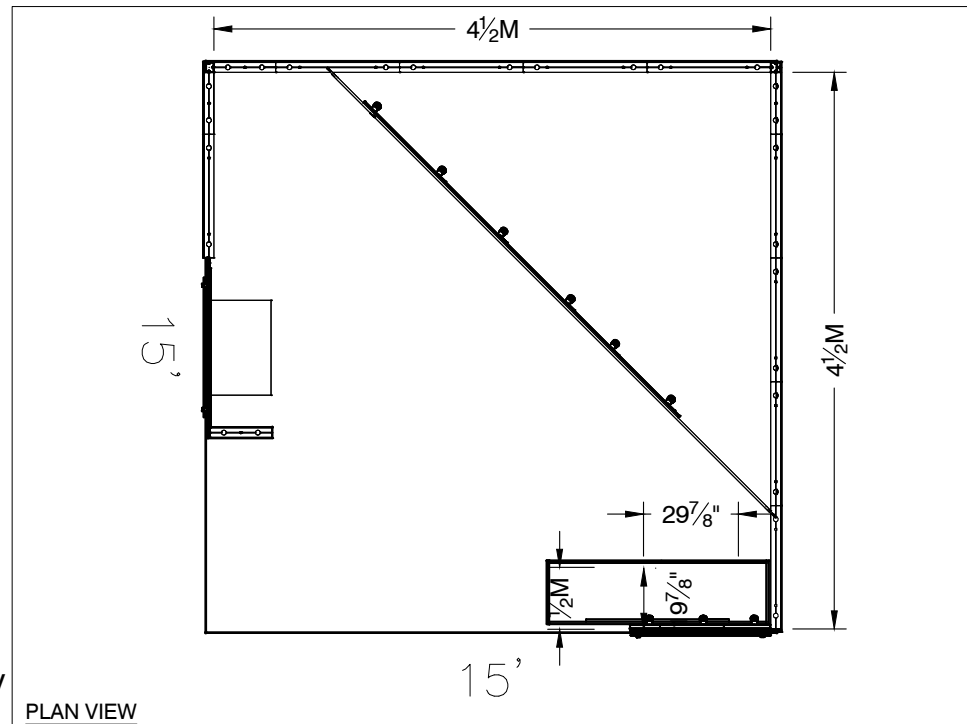
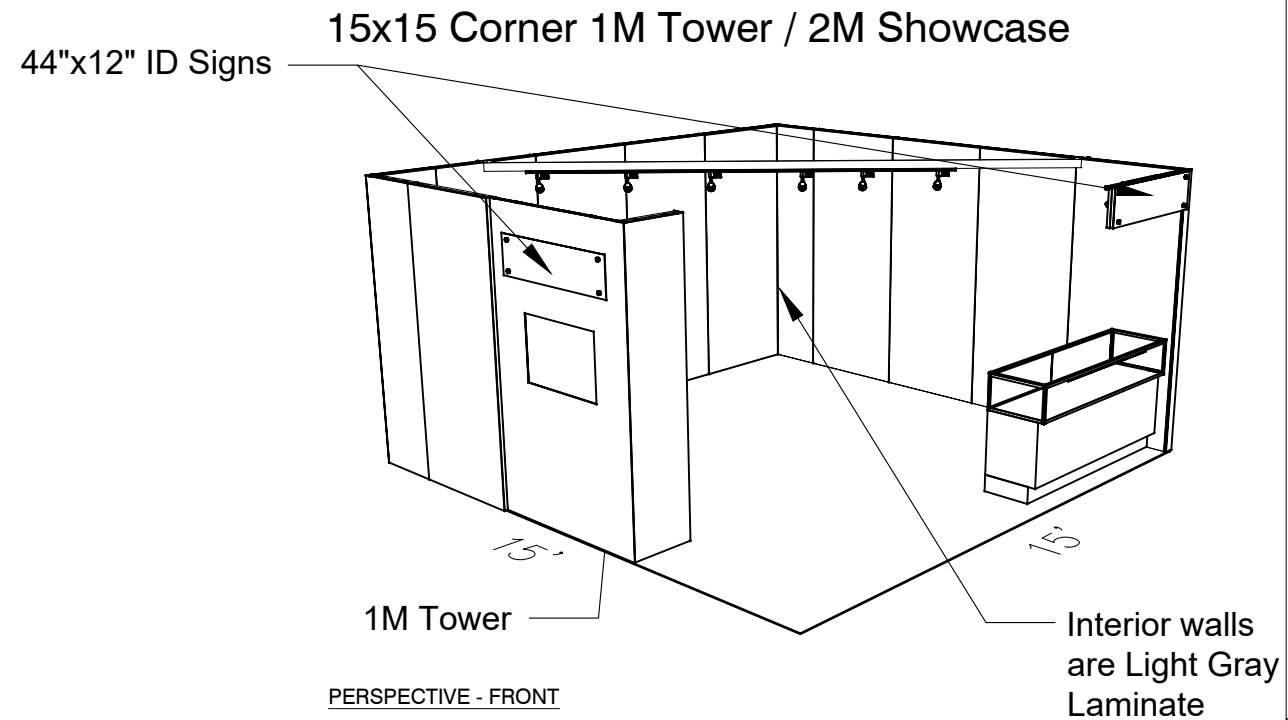

LESS THAN 30 DAYS OUT

\* 0 0 5 0 5 9 0 7 0 1 - 1 0 1 1 - 0 \*

MORE THAN 30 DAYS OUT

\* 0 0 5 0 5 9 0 7 0 1 - 1 0 1 1 - 1 \*